

Iranian Journal of Hydrogen & Fuel Cell

IJHFC

Journal homepage://ijhfc.irost.ir



Development and simulation of a PEM fuel cell model for prediction of water content and power generation

Khaled Mammam^{1,*}, Farid Saadaoui², Abdaldjabar Hazzab²

¹Department of Electrical and Computer Engineering, University of Béchar Bp 417, Algeria.

²CAOSEE Research Laboratory Control, Analysis and Optimization of Systems Electro Energetic systems, University of Tahri Mohamed Bechar, Bp417, Bechar, Algeria.

Article Information

Article History:

Received:

22 Feb 2018

Received in revised form:

13 Mar 2018

Accepted:

13 Mar 2018

Keywords

PEMFC

Electrochemical model

Impedance spectroscopy model

Water diagnosis in fuel cell

Water activity

Flooding drying

Abstract

The proton exchange membrane (PEMFC) fuel cell represents the energy of the future, in parallel with hydrogen. However, this technology must meet many technical challenges related to performance and durability before being sold on a large scale. It is well known that these challenges are closely linked to water management. This paper develops and implements a model of PEM fuel for simulation to make prediction on the water content. The proposed model includes a voltage evolution model based on the electrochemical and dynamics gases aspect, a water activity model to approximate relative humidity and a fuel cell spectroscopy impedance model to estimate the water content in order to make an accurate diagnosis. Furthermore, this work adopts a methods of modeling that presents a new solution to bring water into the fuel cell membrane, where it humidifies the Input gases (air and hydrogen) to a relative humidity over 0%. However, this solution causes a problem of flooding the membrane in the PEMFC. In this work, an Electrochemical Impedance Spectroscopy (EIS) is used to make the flooding and drying diagnosis in the fuel cell. The strengths of this proposed model are that it can be used at the same time in the field of power systems and for water diagnosis. This model predicts the response of step change in the load demand, and the water rate introduced by air into the fuel cell. The simulation results are presented with a qualitative interpretation of PEM fuel cell flooding and drying behavior.

1. Introduction

The PEM fuel cell is the electrochemical element that converts the energy of hydrogen (H_2) into

electricity, using a controlled electrochemical process (instead of a thermal reaction of combustion, whose mechanical work is then generated Converted into electricity).Hydrogen is oxidized at the anode and

*Corresponding Author's Fax: +213 49 23 89 74

E-mail mammam.univ.dz@gmail.com

doi: 10.22104/ijhfc.2018.2792.1168

the protons are transported through the membrane to the cathode according to the reaction [1]-[9]:

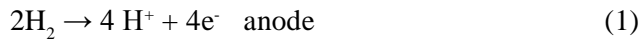

And at the cathode, the oxygen is reduced according to the reaction [1]:

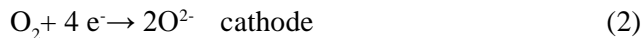

The electrons circulate through the external circuit during these reactions. Once they reach the cathode, the protons recombine with the oxygen ions to form water according to the reaction:

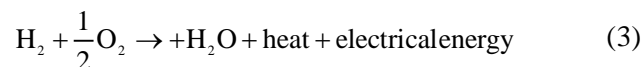

The proton conductivity of a membrane depends strongly on its rate. It must to be saturated with water, this is essential for good ionic conductivity. The most recent solution for hydrating membrane is humidification of Input Gases in Fuel Cell Systems. Where is adopted in our work. This method is based on hydration of gases (with a relative humidity over 0%). Fig. 1 shows the method for brings water into the membrane of fuel cell by hydrating the air and hydrogen. This method is applied specifically for PEM fuel cell type.

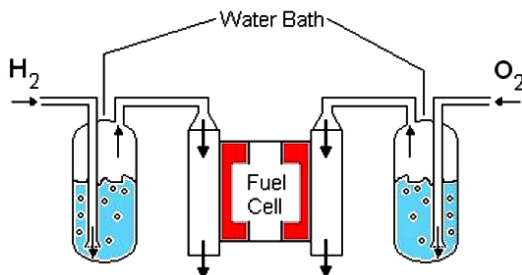

Fig. 1. Basic operation for hydrated gas in a PEMFC [1].

The water management is one of the most critical parameters in the operation of PEM fuel cells [1], [2]. For this, recent research in [14-17] focuses on this theme to achieve the maximum performance and sustainability of PEMFC. The objective of this paper is to define and to implement a new improved

model of PEMFC resulting from recent research for water management and control. This model uses the combination of electrochemical elementary laws and empirical models. Furthermore it includes the dynamic effect of fluid and, relative humidity and voltage losses due to ohmic, activation, and concentration are accounted for. In addition water activity model to calculate relative humidity and fuel cell spectroscopy model to estimate impedance for water diagnosis are implemented. The results of implementation and conclusions for influence of water introduced by the air in the fuel cell are discussed.

2. Fuel cell model

Modeling of PEMFC is a very important part in their development, but it is essential to define the objectives before using the model. This leads to establishing criteria for the use of the model: speed, precision, flexibility, graphical interface, or implementation in software. In this study, we chose to implement a fuel cell model for water management. To do this a model was used to calculate the evolution of the voltage by theoretical and semi-empirical approaches stemming from the work presented by Amphlet [5] and [6]. This model was successfully used by [9] and [10], to control PEM Fuel Cell power generation and by [11] and [12] to implement the power electronic interface. In our work, the thermodynamic equilibrium voltage is defined using the Nernst equation [7]. Activation over voltages are calculated by the Tafel equations [8]. Using Ohm's law, we can express the cell voltage by:

$$V_{cell} = E_{Nerst} - V_{act} - V_{ohm} - V_{con} \quad (4)$$

E_{nerst} is the Nerst voltage defined as:

$$E_{nerst} = 1.229 - 0.85 \times 10^{-3}(T - 298.15) + 4.31 \times 10^{-5} \times T \left[\ln(P_{H_2}) + \frac{1}{2} \ln(P_{O_2}) \right] \quad (5)$$

Where p_{H_2} and p_{O_2} are the partial pressures of

hydrogen and oxygen (atm), respectively, and T the cell operation temperature (K).

V_{act} is the activation voltage loss:

$$V_{act} = -[\xi_1 + \xi_2 \cdot T + \xi_3 \cdot T \cdot (CO_2) + \xi_4 \ln(I_{stack})] \quad (6)$$

Where

I_{stack} : fuel cell operating current (A),

ξ_i : parametric coefficients, and

CO_2 : concentration of oxygen is defined as:

$$CO_2 = \frac{P_{O_2}}{5,08 \cdot 10^6 \cdot e^{(-498/T)}} \quad (7)$$

The concentration voltage loss is calculated as follows:

$$V_{con} = -B \cdot \ln\left(1 - \frac{J}{J_{max}}\right) \quad (8)$$

Where

B: parametric coefficient and

J: current density of the fuel cell.

The Ohmic overvoltage represents voltage loss due to resistance against protons flow in the electrolyte:

$$V_{ohmic} = I_{stack} \left(\frac{t_m}{\sigma} + Rc \right) \quad (9)$$

Where t_m is the membrane thickness.

The proton conductivity of a membrane depends strongly on its rate of hydration (water activity). An empirical formula giving the conductivity of Nafion 117 as a function of its water content was obtained experimentally by Springer et al. [10]:

$$\sigma_m = (0.00519\lambda - 0.00324) \exp\left(1268\left(\frac{1}{303} - \frac{1}{T}\right)\right) \quad (10)$$

Where λ is the membrane water content expressed as a relation by Springer

$$\lambda = \begin{cases} 0.043 + 17.81\phi - 39.85\phi^2 + 36\phi^3, & 0 \leq \phi \leq 1 \\ 14 + 1.4(\phi - 1) & 1 \leq \phi \leq 3 \end{cases} \quad (11)$$

Where ϕ represents the relative humidity.

Boulon et al. in [15] have proposed and examined a model to calculate relative humidity in a PEM fuel cell. They studied the impact of the air supply of a fuel

cell system on humidification and water management issues. It represented the relative humidity of the gases outlets. The relative humidity ϕ was obtained by making the ratio between the partial pressure of vapor P_w and the saturated vapor pressure P_{sat} at temperature T.

$$\phi = \frac{P_w}{P_{sat}(T_{air})} \quad (12)$$

In [15] the saturated vapor pressure was experimentally approached with the Rankin formula:

$$P_{sat} = 10^5 \exp\left(13.7 - \left(\frac{5120}{T_{air} + 273.15}\right)\right) \quad (13)$$

The water content of outgoing air was analyzed in [15] to estimate the relative humidity.

$$P_w = P_{exit} \left(\frac{0.420 + \lambda_a \psi}{\lambda(1 + \psi) + 0.210} \right) \quad (14)$$

P_{exit} : pressure at the stack output. For an atmospheric fuel cell, it is equal to the atmospheric, λ_a : air stoichiometry.

ψ : is calculated from the oxygen molar flow at the input q_{O_2in} and the molar humid air flow q_{win} as:

$$\psi = \left(\frac{q_{win}}{q_{O_2in} + q_{rest}} \right) \quad (15)$$

$$q_{O_2in} = \frac{\lambda_a \cdot I_{stack}}{4 \cdot F} \quad q_{rest} = 3.76 \frac{\lambda_a \cdot I_{stack}}{4 \cdot F}$$

Where q_{rest} is the molar flow of the oxygen component (N_2) of the air.

The relative humidity ϕ is

$$\phi = \frac{P_w}{P_{sat}(T)} = \frac{P_{exit} \left(\frac{0.420 + \lambda_a \psi}{\lambda(1 + \psi) + 0.210} \right)}{10^5 \exp\left(13.7 - \left(\frac{5120}{T_{air} + 273.15}\right)\right)}$$

Electrochemical impedance spectroscopy EIS is used as a water activity diagnosis tool. It is the practical way to estimate the relative humidity in the fuel cell system. The Electrochemical impedance model was presented by The Randles cell in [16 - 18]. It is an equivalent circuit as show in Fig. 2. The general

expression of the diffusion impedance for a finite length diffusion layer is given by [17]:

$$Z_w(j\omega) = \frac{RT}{n^2 F^2 S \sqrt{j\omega}} \frac{\tanh \sqrt{((j\omega)/D)\delta^2}}{C\sqrt{D}} \quad (18)$$

This relation can be simplified as:

$$Z_w(j\omega) = R_d \frac{\tanh \sqrt{(j\omega)(\tau_d)}}{C\sqrt{\tau_d}} \quad (19)$$

$$\tau_d = \frac{\delta^2}{D} \quad (20)$$

Additionally, the resistance can be calculated by:

$$R_d = \frac{RT\delta}{n^2 F^2 SCD} \quad (21)$$

The overall impedance of Fig. 2 is [17]:

$$Z_r(j\omega) = R_m + \frac{1}{Q(j\omega)^\alpha + (1/(R_p + Z_w))} \quad (22)$$

With the value of α usually ranging between 0.5 and 1.

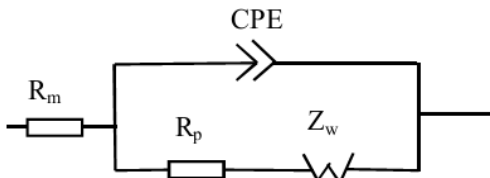

Fig. 2. Randles cell with CPE impedance.

The remaining parameters (R_d , R_p , τ_d and Q) are identified in [18] by using experimental Factorial Design methodology fitting to evaluate the respective impacts of the relative humidity RH (%) and Time t(s) on the FC impedance operation:

$$R_p = 0.0118 + 0.00334376t^* + 0.000557375RH^* + 0.00150034t^*RH^* \quad (23)$$

$$R_d = 0.01245 + 0.00944438t^* + 0.00553026RH^* + 0.00770649t^*RH^* \quad (24)$$

$$\tau_d = 0.120225 + 0.0221923t^* + -0.0326524RH^* - 0.0219176t^*RH^* \quad (25)$$

$$Q = 0.90425 - 0.148901t^* + 0.1275RH^* + 0.0667517t^*RH^* \quad (26)$$

Finally, to calculate the relationship between flow rate and partial pressure, all individual gases are considered separately and the ideal gas equation was applied to each. The model was developed by El-Sharkh et al. in [13 - 14]. The state equations become:

$$\frac{d}{dt}(P_{H_2}) = \frac{RT}{V_{an}}(q_{H_2in} - q_{H_2out} - q_{H_2r}) \quad (27)$$

$$\frac{d}{dt}(P_{O_2}) = \frac{RT}{V_{an}}(q_{O_2in} - q_{O_2out} - q_{O_2r}) \quad (28)$$

$$\frac{d}{dt}(P_w) = \frac{RT}{V_{an}}(q_{win} - q_{wout} - q_{wr}) \quad (29)$$

Where:

P_w : the partial pressures of each gas inside cell,

q_{H_2in} , q_{O_2in} : the inlet flow rates of hydrogen and oxygen,

q_{H_2out} , q_{O_2out} and q_{wout} : the outlet flow rates of each gas and water vapor, and

q_{H_2r} , q_{O_2r} and q_{wr} : usage and production of the gases and water.

Based on the electrochemical relationships, we have [8]:

$$q_{H_2r} = 2q_{O_2r} = q_{wr} = \frac{N_0 \cdot I_{stack}}{2F} = 2 \cdot K_r \cdot I_{stack} \quad (30)$$

$$q_{H_2out} = K_{H_2} P_{H_2}; q_{O_2out} = K_{O_2} P_{O_2}; q_{wout} = K_w P_w \quad (31)$$

Where K_{H_2} : hydrogen valve molar constant [kmol/(atm s)], K_{O_2} : oxygen valve molar constant (kmol/(atm s)), N_0 number of series fuel cells in the stack, I_{stack} : stack current (A), K_r : constant = $N_0/4F$ Kmol/(s.A), and F : Farady constant 9684600 C/Kmol.

By substituting equations (12) and (15) into equation (16), applying the Laplace transform, and isolating the partial pressure term, the following equation can be written as:

$$P_{H_2} = \frac{1/K_{H_2}}{1 + \tau_{H_2} s} (q_{H_2} - 2K_r I_{stack}) \quad (32)$$

where τ_{H_2} is the time constant related to the system

that associates hydrogen flow and partial pressure of hydrogen.

3. Model Test and validation

The goal of this section is to test and verify the

performances of the proposed models. The model equations were simulate under a Matlab environment using the parameters presented in Table 1.

The results are related to the voltage / current and pressure characteristic at a constant stack temperature of 90o and water activity in membrane of 100%. The results are presented in 3D in Fig, 3

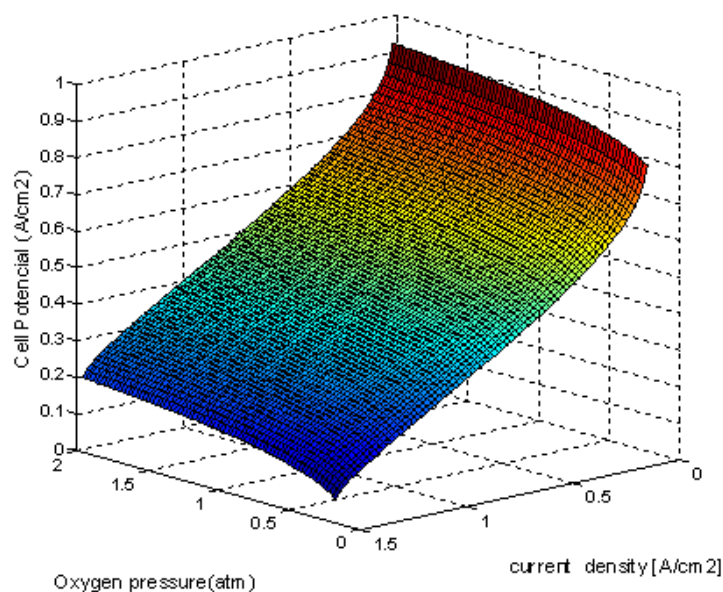

Fig. 3. Polarization curve of the PEMFC with simultaneous changes in the inlet partial pressure oxygen and current density at stack temperature of 90o and water activity in membrane of 100%.

Table 1. Model parameters from [20 and 21]

Parameters	Values
Temperature T	(K)
l	178 μm
J_{max}	1.5 A/cm ²
J_{n}	1.2 A/cm ²
B	0.016 V
λ_{a} air stoichiometry	2
Active area S	56.6 cm ²
ζ_1	-0.948
ζ_2	0.00286+0.0002.lnA+(4.3.10 ⁻⁵)lnCH ₂
ζ_3	7.6.10 ⁻⁵
ζ_4	-1.93.10 ⁻⁴
Number of cells N_0	100
Hydrogen valve constant K_{H_2}	4.22*10 ⁻⁵ Kmol/(s.A)
Oxygen valve constant K_{O_2}	2.11*10 ⁻⁵ Kmol/ (s.atm)
Hydrogen time constant, τ_{H_2}	3.37 (s)
Oxygen time constant, τ_{O_2}	6.74 (s)
Hydrogen –Oxygen flow ratio $r_{\text{H}_2\text{O}}$	1.168
Kr constant = $N_0/4F$	0.996*10 ⁻⁶ Kmol/ (s.A)

and are in good agreement with experimental BCS 500-W manufacture data as show in [19-21]. It should be noted that the simulations proposed in [10], [19], and [14] do not show the influence of relative humidity (RH) on the polarizations curve. However, we can see that this relative humidity (RH) strongly influences the voltage drop, as shown experimentally in Fig. 4. Moreover, when the voltage curve of the flooded and the dry membrane are approximately superposed it is impossible to make a diagnosis of which case (flooded or dry) caused the voltage drop.

That is why in this work we proposed a technique based on an electrochemical Impedance Spectroscopy (EIS) for diagnosis. The influence of relative humidity on the polarizations curve of the PEMFC is shown in Fig. 5. The results proposed in this figure are validated by the experimental results of Fig. 4. This characteristic can be decomposed into three zones:

1. The flood zone, where the water cannot be completely evacuated and the fuel cell begins to become flooded.

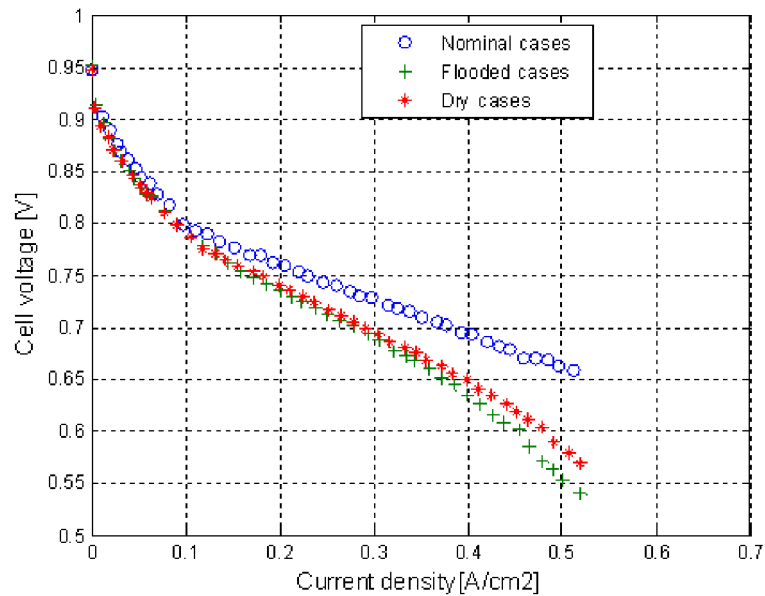

Fig. 4. Experimental polarization curves for a fuel cell working under flooded, dry and nominal conditions. Measured by Fouquet et al. in [11].

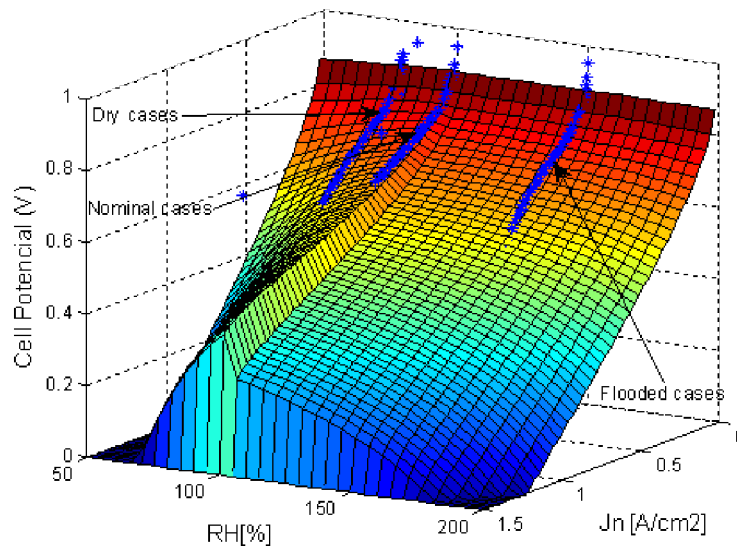

Fig. 5. Polarization curve of the PEMFC with simultaneous changes in water of relative humidity and current density at a stack temperature of 90°C. * Experimental polarization curves from Fig. 4.

2.The dry zone, where the air dries up the membrane causing the fuel cell to shift into a defect state (and possible irreversible degradation).

3.The objective zone, where the water in the inlet air and the water produced by the electrochemical reaction equal the water amount in the output air. And the maximum voltage is produced by the fuel cell as described in Fig. 5.

Fig. 6 estimates the relative humidity at the output of the fuel cell with simultaneous changes in the humid

air flow in the fuel cell q_{win} and current density, at a constant stack temperature of 90o.. The idea is to determine if the humid air flow at the inlet of the fuel cell q_{win} stays in the objective zone. And to characterize the flooding or drying of the fuel cell heart (membrane and electrodes).

Fig. 7 represents three main Randles impedance cells improved by the constant phase element (CPE) and fitting the experimental data which validate the impedance model:

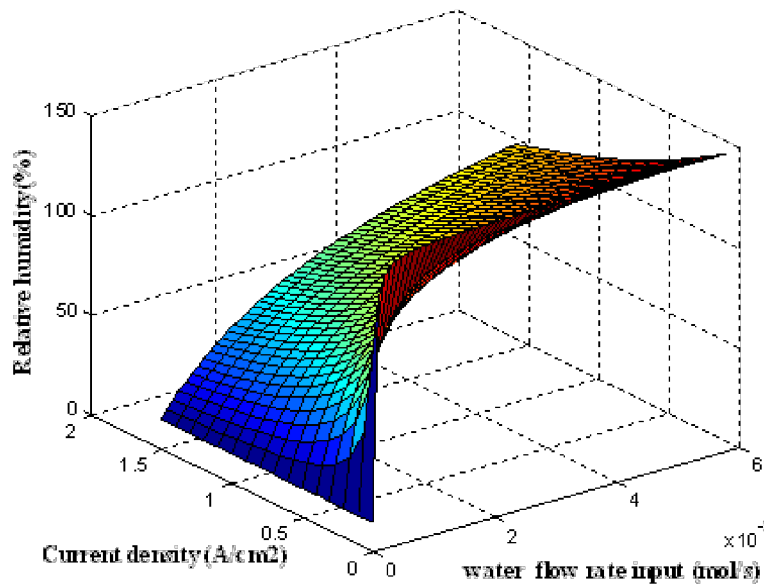

Fig. 6. Relative humidity (%) curve of the PEMFC with simultaneous changes in water introduced by the air and current density.

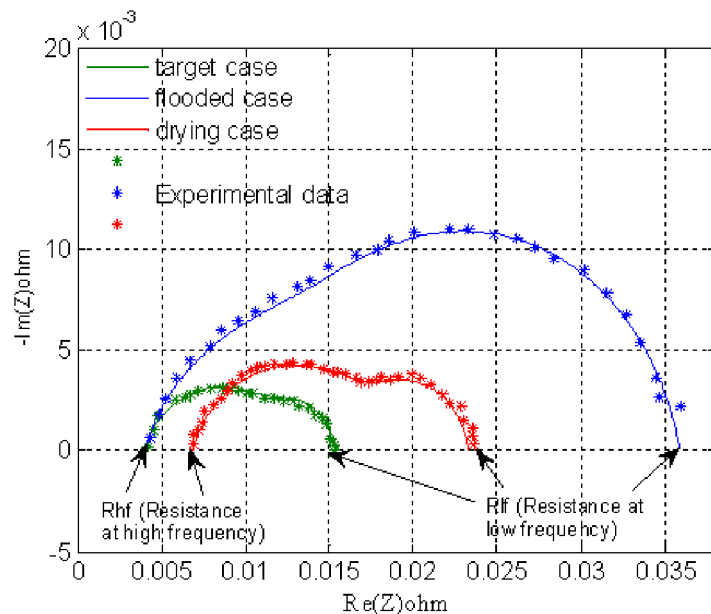

Fig. 7. PEMFC impedance in the Nyquist plot.

1-Impedance in the objective case where it is characterized by small resistance measured in the low and high frequency and small phase angle arcs (small capacitive effect).

2- Impedance in the flooding case characterized by a big arc (more capacitive effect). The resistance measured in the low frequency is large; however, there is no shift of resistance measured at high frequency

3-Impedance in the dehydration effect, it can be seen in the Nyquist plot impedance which shows a rise in the resistance measured at high frequency R_{hf} .

4. Simulation Results and Discussion

The proposed model of PEM Fuel cell is implemented as show in Fig. 8 with parameters given in Table 1. It is tested with step change of humid air flow in the fuel cell (q_{win}) and current as shown in Fig. 9. This figure also shows the change in relative humidity of air at the cathode. This is related to molar humid air flow in the fuel cell (q_{win}). For this reason, it is essential to obtain the objective zone (ϕ 100%) by management

management and control of the humid air flow. The Nyquist plot impedance from the EIS model can make a diagnosis for the flooding or drying case.

The result of the impedance behavior is shown in Fig. 10. It is characterized by the progressive increase of the arc, for times varying between (0 to 3500 sec) under flooding and drying conditions.

For the time intervals [500 sec to 1000 sec] and [2000 sec to 3000 sec] it is observed that there is no variation in the resistance at high-frequency in the Nyquist plot. This characterizes the hydrated case. This behavior is realized by the increase of the fuel cell current density which induces an increase of water production at the cathode which causes blocking of the reaction; thus, the decrease in the fuel cell output [14] can lead to the flooding case.

The Nyquist plot in the interval (1000 sec to 2000 sec) characterizes the dehydration effect, illustrated in Fig. 9 as an increase in the high frequency resistance. In the high load condition the fuel cell current density increases, which provokes an increase of temperature and can lead to the drying case.

In [16] and [18] a robust and reliable PEM fuel cell's state of hydration monitoring was demonstrated

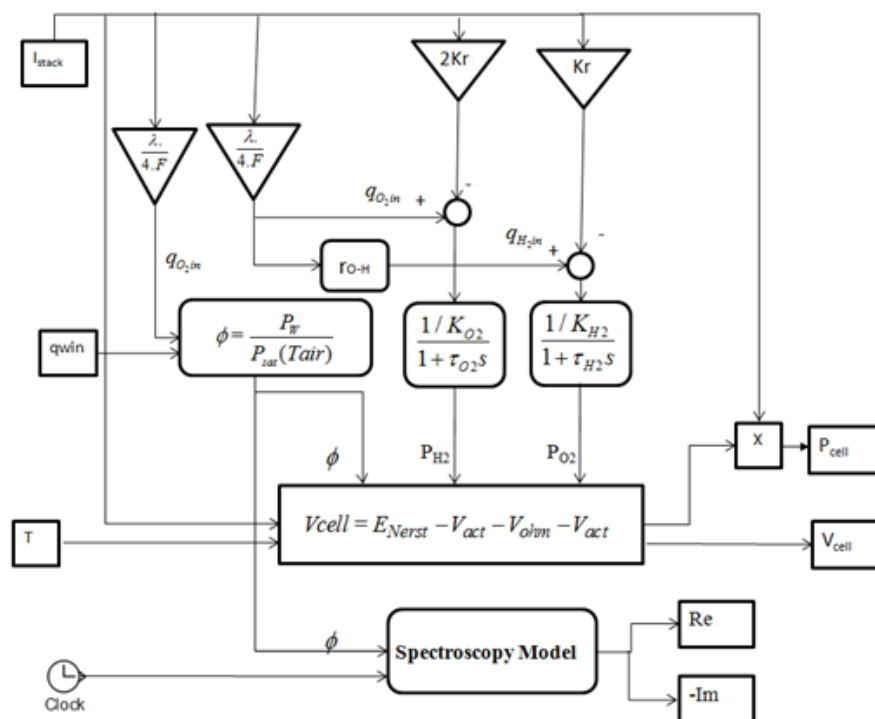

Fig.8. PEM fuel cell block diagram.

based on the resistance measured at high frequency of impedance, R_{hf} , and the resistance measured at low frequency, R_{lf} . Fig. 9 shows the change of the resistance of spectroscopy impedance measured at a low frequency (R_{lf}) increasing gradually with time; however, when the relative humidity decreases from 140% at 40% as shown at 1000 sec (from flooding to drying) the R_{hf} goes down.

The resistance measured at high stack frequency (R_{lf}), as seen in Fig. 9, increases and decreases according

the relative humidity and molar humid air flow.

5. Conclusion

In this paper, an improved PEMFC model is developed and implemented to study water activity in a fuel cell at different operating conditions. The proposed model includes an enhanced steady dynamic electrochemical model and a spectroscopy impedance (EIS) model as an estimator of relative humidity. This

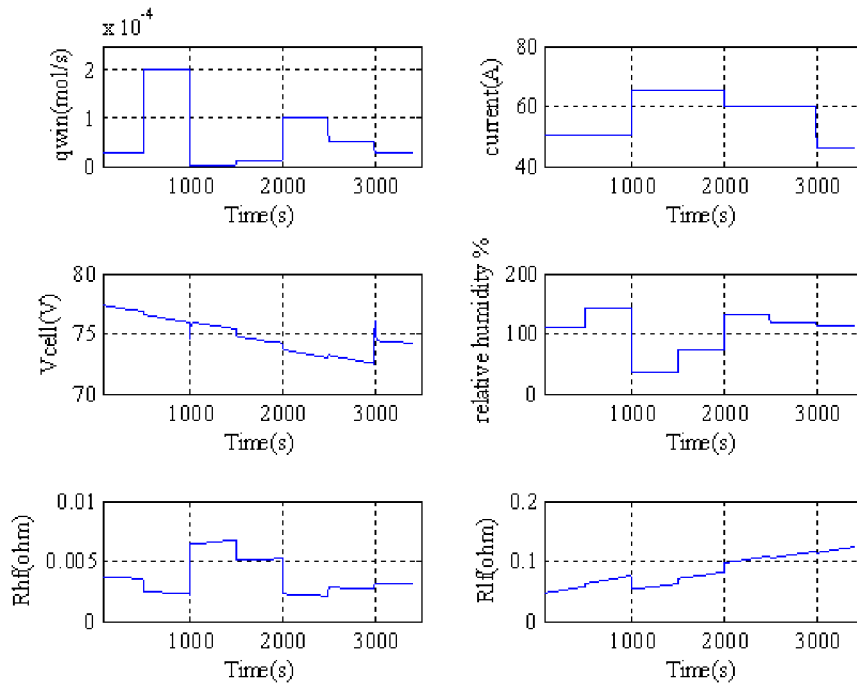

Fig. 9. Simulation results for the PEM fuel cell.

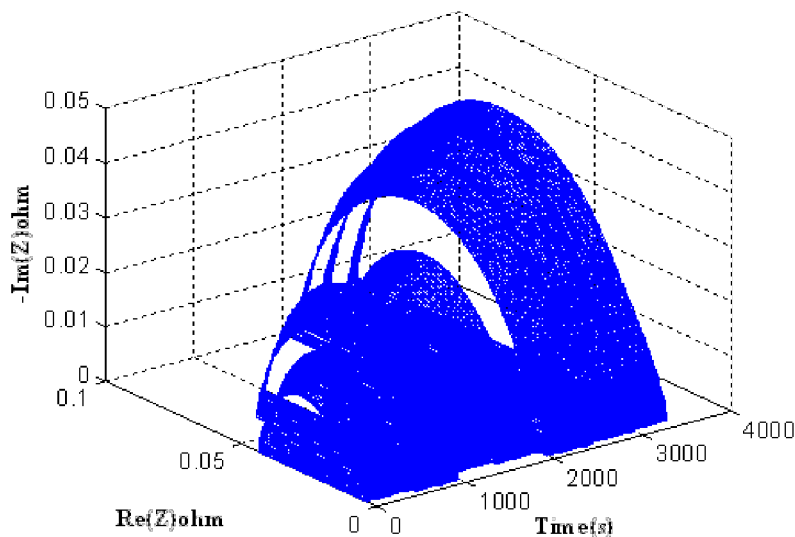

Fig.10. PEMFC impedance behavior in the Nyquist plot.

model was tested on simulation data and the obtained results confirm it is relatively easy to use this model to control relative humidity by controlling molar humid air flow in the fuel cell. Consequently, it is usable in a real time control loop to improve the humid air supply for water management. Moreover, the spectroscopy impedance EIS model, represented by Nyquist plot, helps to recognize the conditions of flooding or drying cases. Nevertheless, this preliminary work does not provide how the control of molar humid air flow in the fuel cell is done. Future works will be required to develop a more specific algorithm for control based on this model. It would also be interesting to use the Intelligent Controller for water management.

References

- [1] Atilla Bıyıkoğlu, "Review of proton exchange membrane fuel cell models". *International Journal of Hydrogen Energy*, 2005, 30, 1181.
- [2] R. F. Mann, J. C. Amphlett et al., "Development and application of a generalized steady-state electrochemical model for a PEM fuel cell". *J. Power Sources*, 2000, 86, 173.
- [3] G. Dotelli, R. Ferrero, "Diagnosis of PEM Fuel Cell Drying and Flooding Based on Power Converter Ripple". *IEEE transactions on instrumentation and measurement*, 2014, 63.
- [4] K. Murugesan and V. Senniappan, "Investigation of Water Management Dynamics on the Performance of a Ballard-Mark-V Proton Exchange Membrane Fuel Cell Stack System". *International Journal of electrochemical science*, 2013, 7885.
- [5] J. C. Amphlett, et al., "A model predicting transient responses of proton exchange membrane fuel cells". *J. Power Sources*, 1996, 61, 183.
- [6] R. F. Mann, J. C. Amphlett et al., "Development and application of a generalized steady-state electrochemical model for a PEM fuel cell". *J. Power Sources*, 2000, 86, 173.
- [7] Jeferson M. Corra et al., "Applications Simulation of Fuel-Cell Stacks Using a Computer- Controlled Power Rectifier With the Purposes of Actual High- Power Injection. *IEEE Transactios on Industrial*, 2003, 39.
- [8] Jeferson M. Corra et al., "An Electrochemical-Based Fuel-Cell Model Suitable for Electrical Engineering Automation Approach"., *IEEE Transactios on Industrial Electronics*, 2004, 51.
- [9] Khaled Mammar, "Abdelkader Chaker. Fuzzy Logic Control of Fuel Cell System for Residential Power Generation." *Journal of Electrical Engineering*, 2009, 60, 328.
- [10] K. Mammar, A. Chaker. "Neural Network-Based Modeling of PEM fuel cell and Controller Synthesis of a stand-alone system for residential application", *International Journal of Computer Science*, 2012, 1694.
- [11] M.Harinee V.S. Nagarajan, "Modeling and Design of Fuel Cell based Two Phase Interleaved Boost Converter". *1st International Conference on Electrical Energy Systems 2011 IEEE*.
- [12] R Seyezhai, B.L. Mathur, "Modeling and control of PEM fuel cell based hybrid multilevel inverter". *International Journal of Hydrogen Energy*, 2011, 36, 15029.
- [13] M. Y. El-Sharkh, A. Rahman, "Analysis of Active and Reactive Power Control of a Stand-Alone PEM Fuel Cell Power Plant". *IEEE Transactios on Power Systems*, 2004, 19, 4.
- [14] M. Y. El-Sharkh and M.placeS Alam, "A dynamic model for a stand-alone PEM fuel cell power plant for residential application". *J. Power Sources*, 2004, 138, 199.
- [15] L. Boulon and al, "Energy management of a fuel cell system: Influence of the air supply control on the water

issues " IEEE International Symposium on Industrial Electronics (ISIE) 4-7 , 2010.

[16] Slimane Laribi, Khaled Mammar and al. " Impedance model for diagnosis of water management in fuel cells using artificial neural networks methodology". *International Journal of Hydrogen Energy*, 2016, 41, 17093.

[17] N. Fouquet et al., "Model based PEM fuel cell state-of-health monitoring via ac impedance measurements". *Journal of Power Sources*, 2006, 905.

[18] K. Mammar and B.O. Bouamama, "Analysis of Impedance for Water management in Proton Exchange membrane Fuel Cells using Factorial Design of (DoE) Methodology". *International Mechanical Engineering Congress & Exposition*, 2013, 63475.

[19] Khaled Mammar, Abdelkader Chaker. "A Central Composite Face-Centered Design for Parameters Estimation of PEM Fuel Cell Electrochemical Model" *Leonardo Journal of Sciences*, 2013, 23, 84.

[20] G. N. Srinivasulu et al., "Parametric sensitivity analysis of PEM fuel cell electrochemical Model". *International Journal of Hydrogen Energy*, 2011, 36, 14838.

[21] W. Friede, S. Raël et B. Davat, " Mathematical model and characterization of the transient behavior of a PEM fuel cell", *Trans. on Power Electronics*, 2004, 19, 1234.